

DeWALT Industrial Tool Co.,
701 East Joppa Road, Baltimore, MD 21286 • 20 Fletcher Road, Mooroolbark, VIC 3138 Australia
(FEB06) Form No. 635606-00 DW310-XE, DW311-XE Copyright © 2006 DeWALT

The following are trademarks for one or more DeWALT power tools: the yellow and black color scheme; the “D” shaped air intake grill; the array of pyramids on the handgrip; the kit box configuration; and the array of lozenge-shaped humps on the surface of the tool.

IF YOU HAVE ANY QUESTIONS OR COMMENTS ABOUT THIS OR ANY DeWALT TOOL, CALL US AT: **1800 654 155** (Aust) or **09 526 2556** (NZ).

SAFETY INSTRUCTIONS FOR POWER TOOLS

When using power tools, always observe the safety regulations applicable in your country to reduce the risk of fire, electric shock and personal injury. Read the following safety instructions before attempting to operate this product. Keep these instructions in a safe place.

General Safety Rules

▲WARNING! Read all instructions. Failure to follow all instructions listed below may result in electric shock, fire and/or serious injury. The term “power tool” in all of the warnings listed below refers to your mains operated (corded) power tool or battery operated (cordless) power tool.

SAVE THESE INSTRUCTIONS

1. WORK AREA

- Keep work area clean and well lit.** Cluttered and dark areas invite accidents.
- Do not operate power tools in explosive atmospheres, such as in the presence of flammable liquids, gases or dust.** Power tools create sparks which may ignite the dust or fumes.
- Keep children and bystanders away while operating a power tool.** Distractions can cause you to lose control.

2. ELECTRICAL SAFETY

- Power tool plugs must match the outlet. Never modify the plug in any way. Do not use any adapter plugs with earthed (grounded) power tools.** Unmodified plugs and matching outlets will reduce risk of electric shock.
- Avoid body contact with earthed or grounded surfaces such as pipes, radiators, ranges and refrigerators.** There is an increased risk of electric shock if your body is earthed or grounded.
- Do not expose power tools to rain or wet conditions.** Water entering a power tool will increase the risk of electric shock.
- Do not abuse the cord. Never use the cord for carrying, pulling or unplugging the power tool. Keep cord away from heat, oil, sharp edges or moving parts.** Damaged or entangled cords increase the risk of electric shock.
- When operating a power tool outdoors, use an extension cord suitable for outdoor use.** Use of a cord suitable for outdoor use reduces the risk of electric shock.

3. PERSONAL SAFETY

- Stay alert, watch what you are doing and use common sense when operating a power tool. Do not use a power tool while you are tired or under the influence of drugs, alcohol or medication.** A moment of inattention while operating power tools may result in serious personal injury.
- Use safety equipment. Always wear eye protection.** Safety equipment such as dust mask, non-skid safety shoes, hard hat, or hearing protection used for appropriate conditions will reduce personal injuries.
- Avoid accidental starting. Ensure the switch is in the off position before plugging in.** Carrying power tools with your finger on the switch or plugging in power tools that have the switch on invites accidents.
- Remove any adjusting key or wrench before turning the power tool on.** A wrench or a key left attached to a rotating part of the power tool may result in personal injury.
- Do not overreach. Keep proper footing and balance at all times.** This enables better control of the power tool in unexpected situations.
- Dress properly. Do not wear loose clothing or jewellery. Keep your hair, clothing and gloves away from moving parts.** Loose clothes, jewellery or long hair can be caught in moving parts.
- If devices are provided for the connection of dust extraction and collection facilities, ensure these are connected and properly used.** Use of these devices can reduce dust related hazards.

4. POWER TOOL USE AND CARE

- Do not force the power tool. Use the correct power tool for your application.** The correct power tool will do the job better and safer at the rate for which it was designed.
- Do not use the power tool if the switch does not turn it on and off.** Any power tool that cannot be controlled with the switch is dangerous and must be repaired.
- Disconnect the plug from the power source before making any adjustments, changing accessories, or storing power tools.** Such preventive safety measures reduce the risk of starting the power tool accidentally.
- Store idle power tools out of the reach of children and do not allow persons unfamiliar with the power tool or these instructions to operate the power tool.** Power tools are dangerous in the hands of untrained users.
- Maintain power tools. Check for misalignment or binding of moving parts, breakage of parts and any other condition that may affect the power tools operation. If damaged, have the power tool repaired before use.** Many accidents are caused by poorly maintained power tools.

- Keep cutting tools sharp and clean.** Properly maintained cutting tools with sharp cutting edges are less likely to bind and are easier to control.
- Use the power tool, accessories and tool bits etc., in accordance with these instructions and in the manner intended for the particular type of power tool, taking into account the working conditions and the work to be performed.** Use of the power tool for operations different from those intended could result in a hazardous situation.

5. SERVICE

- Have your power tool serviced by a qualified repair person using only identical replacement parts.** This will ensure that the safety of the power tool is maintained.

Electrical Safety

The electric motor has been designed for one voltage only. Always check that the power supply corresponds to the voltage on the rating plate. 230 V AC means your tool will operate on alternating current. As little as 10% lower voltage can cause loss of power and can result in overheating. All DeWALT tools are factory tested; if this tool does not operate, check the power supply. Your DeWALT tool is double insulated, therefore no earth wire is required.

- Young children and the infirm.** This appliance is not intended for use by young children or infirm persons without supervision. Young children should be supervised to ensure that they do not play with this appliance.
- Replacement of the supply cord.** If the supply cord is damaged, it must be replaced by the manufacturer or an authorised DeWALT Service Centre in order to avoid a hazard.

Extension Cords

▲CAUTION: Use only extension cords that are approved by the country’s Electrical Authority. Before using extension cords, inspect them for loose or exposed wires, damaged insulation and defective fittings. Replace the cord if necessary.

Additional Safety Instructions

- Hold tool by insulated gripping surfaces when performing an operation where the cutting tool may contact hidden wiring.** Contact with a “live” wire will make exposed metal parts of the tool “live” and shock the operator.
- Use clamps or another practical way to secure and support the workpiece to a stable platform.** Holding the work by hand or against your body leaves it unstable and may lead to loss of control.
- Keep hands away from moving parts.** Never place your hands near the cutting area.
- Keep hands away from cutting area.** When sawing, never reach underneath or behind the material being cut for any reason.
- Never hold work in your hand, lap or against parts of your body when sawing.** The saw may slip and the blade could contact the body causing injury.
- Use extra caution when cutting overhead and pay particular attention to overhead wires which may be hidden from view.** Anticipate the path of falling branches and debris ahead of time.
- Do not operate this tool for long periods of time.** Vibration caused by the operating action of this tool may cause permanent injury to fingers, hands, and arms. Use gloves to provide extra cushion, take frequent rest periods, and limit daily time of use.

▲WARNING: Some dust created by power sanding, sawing, grinding, drilling, and other construction activities contains chemicals known to cause cancer, birth defects or other reproductive harm. Some examples of these chemicals are:

- lead from lead-based paints,
- crystalline silica from bricks and cement and other masonry products, and
- arsenic and chromium from chemically-treated lumber (CCA).

Your risk from these exposures varies, depending on how often you do this type of work. To reduce your exposure to these chemicals: work in a well ventilated area, and work with approved safety equipment, such as those dust masks that are specially designed to filter out microscopic particles.

- Avoid prolonged contact with dust from power sanding, sawing, grinding, drilling, and other construction activities.** Wear protective clothing and wash exposed areas with soap and water. Allowing dust to get into your mouth, eyes, or lay on the skin may promote absorption of harmful chemicals.

▲WARNING: Use of this tool can generate and/or disburse dust, which may cause serious and permanent respiratory or other injury. Always use NIOSH/OSHA approved respiratory protection appropriate for the dust exposure. Direct particles away from face and body.

▲WARNING: Always use eye protection. All users and bystanders must wear eye protection that conforms to ANSI Z87.1.

▲CAUTION: Wear appropriate personal hearing protection during use. Under some conditions and duration of use, noise from this product may contribute to hearing loss.

- The label on your tool may include the following symbols. The symbols and their definitions are as follows:

V	volts	A	amperes
Hz	hertz	W	watts
min	minutes	~	alternating current
====	direct current	n ₀	no load speed
☐	Class II Construction	⊕	earthing terminal
▲	safety alert symbol	.../min	revolutions per minute
sfp _m	surface feet per minute		

SAVE THESE INSTRUCTIONS

COMPONENTS (FIG. 1, 2)

- | | |
|----------------------------------|-----------------------|
| A. Trigger switch (VS) | F. Blade clamp collar |
| B. Variable speed selector wheel | G. Hand grip |
| C. Shoe release lever | H. Rear handle |
| D. Adjustable shoe | |
| E. Blade action selector | |

TRIGGER SWITCH

The variable speed trigger switch (A) will give you added versatility. The further the trigger is depressed the higher the speed of the saw. To turn the tool OFF, release the trigger.

NOTE: This tool has no provision to lock the switch in the ON position, and should never be locked ON by any other means.

▲CAUTION: Use of very slow speed is recommended only for beginning a cut. Prolonged use at very slow speed may damage your saw.

VARIABLE SPEED SWITCH AND SELECTOR WHEEL

Both saws are equipped with a variable speed control (0 to 2600 SPM). As the trigger switch is depressed, the speed of the saw blade increases.

The DW311 has a variable speed selector wheel (B) to control the speed of the tool. To select a slow speed for operating your saw, rotate the wheel to a low number on the dial. To select a higher speed, rotate the wheel to a higher number.

The lower speeds are recommended for most metal cutting, while the higher speeds are recommended for wood. A few practice cuts on scrap material at various speeds will aid you in choosing the best speed for obtaining the desired results for your application.

Dual Blade Motion (DW311 Only) (Fig. 2)

The DW311 has dual blade motion: straight reciprocating motion or orbital motion.

Straight reciprocating motion is used for all metal cutting operations and for wood cutting applications where finish is more important than speed. To set the saw for straight reciprocating motion, turn the blade action selector (E) 45° clockwise to align the mark (I) with the arrow on the tool (J), as shown.

Orbital motion is used for fast cutting of wood. To set the saw for orbital action, turn the blade action selector 45° counterclockwise to align the mark (K) with the arrow on the tool (J), as shown.

Adjustable Shoe (Fig. 3)

▲CAUTION: Turn off and unplug the tool before making any adjustments or removing or installing attachments or accessories.

Push the shoe release lever (C) downward and slide the shoe (D) out to the desired setting. Rotate the lever to lock shoe into position.

▲CAUTION: Cut hazard. To prevent loss of control, never use tool without shoe.

▲CAUTION: Risk of personal injury and property damage. Ensure the shoe is locked into position before using tool.

Blade Installation and Removal (Fig. 4, 5)

Different blade lengths are available. Use the appropriate blade for the application. The blade should be longer than 88.9mm (3-1/2") and should extend past the shoe and the thickness of the workpiece during the cut. Select the blade best suitable for the material to be cut and use the shortest blade suitable for the thickness of the material. Do not use jigsaw blades with this tool.

▲WARNING: Cut hazard. Blade breakage may occur if the blade does not extend past the shoe and the workpiece during the cut (Fig. 5). Increased risk of personal injury, as well as damage to the shoe and workpiece may result.

▲WARNING: Cut hazard. Turn off and unplug the tool before making any adjustments or removing or installing attachments or accessories.

TO INSTALL BLADE INTO SAW (FIG. 4)

- Point tool away from body.
- Rotate blade clamp collar (F) to release position.
- Insert blade shank from the front.
- Rotate blade clamp collar to lock blade into position.

NOTE: Blade can be installed upside-down to assist in flush-to cutting, see Figure 7.

TO REMOVE BLADE FROM SAW

⚠WARNING: Burn hazard. Do not touch the the blade immediately after use. Contact with the blade may result in personal injury.

1. Rotate blade clamp collar (F) to release position.
2. Remove blade.

OPERATION

⚠WARNING: Always wear eye protection while operating this or any other power tool.

⚠WARNING: Burn hazard. Do not touch the the blade immediately after use. Contact with the blade may result in personal injury.

Before you begin work, ensure the material to be cut is rigid. Small workpieces should be securely clamped to the work table.

PROPER HAND POSITION

Grasp the underside of the hand grip (G) with one hand and the rear handle (H) with the other hand.

Cutting (Fig. 6)

⚠WARNING: Always wear eye protection while operating this power tool.

⚠WARNING: Cut hazard. Exercise extra caution when cutting towards operator. Always hold saw firmly with both hands while cutting.

Before cutting any type of material, be sure it is firmly anchored or clamped to prevent slipping. Place blade lightly against work to be cut, depress the trigger switch and allow it to obtain maximum speed before applying pressure. Whenever possible, the saw shoe must be held firmly against the material being cut. This will prevent the saw from jumping or vibrating and minimize blade breakage. Any cut which puts pressure on the blade, such as angle or scroll cuts, increase potential for vibration, kickback and blade breakage.

NOTE: The blade cuts on the down stroke leaving the cleanest edge on the underside of the material.

⚠WARNING: Shock hazard. Use extra caution when cutting overhead and pay particular attention to overhead wires which may be hidden from view.

⚠WARNING: Use extra caution when cutting overhead and anticipate the path of falling branches and debris ahead of time.

⚠WARNING: Inspect work site for hidden gas pipes, water pipes, or electrical wires before making blind or plunge cuts. Failure to do so may result in explosion, property damage, electric shock, and/or serious personal injury.

FLUSH-TO CUTTING (FIG. 7)

The compact design of the saw motor housing and spindle housing permits extremely close cutting to floors, corners and other difficult areas. The blade can be installed upside-down to assist in flush-to cutting

POCKET/PLUNGE CUTTING – WOOD ONLY (FIG. 8)

⚠WARNING: Shock hazard. Exercise extreme caution when blind cutting to ensure that there are no foreign objects such as electrical wire, conduit, plumbing pipes, etc., that may come in contact with the blade.

NOTE: DO NOT attempt to pocket/plunge cut metal.

The initial step in pocket/plunge cutting is to measure the surface area to be cut and mark clearly with a pencil, chalk or scribe. Use the appropriate blade for the application. The blade should be longer than 88.9mm (3-1/2") and should extend past the shoe and the thickness of the workpiece during the cut. Insert blade in blade clamp.

Next, tip the saw backward until the back edge of the shoe is resting on the work surface and the blade clears the work surface. Depress trigger switch to turn motor on, always permitting blade to attain maximum speed. Grip saw steadily and begin a slow, deliberate upward swing with the handle of the saw. Blade will begin to feed into material. Always be sure blade is completely through material before continuing with pocket/plunge cut.

NOTE: In areas where blade visibility is limited, use the edge of the saw shoe as a guide. Lines for any given cut should be extended beyond edge of cut to be made.

METAL CUTTING (FIG. 9)

This unit has different metal cutting capacities depending upon type of blade used and the metal to be cut. Use a finer blade for ferrous metals and a coarse blade for non-ferrous materials. In thin gauge sheet metals it is best to clamp wood to both sides of sheet. This will insure a clean cut without excess vibration or tearing of metal. Always remember not to force cutting blade as this reduces blade life and causes costly blade breakage. Start the cut on the surface where the greatest number of teeth will contact the workpiece.

NOTE: It is generally recommended that when cutting metals you should spread a thin film of oil or other lubricant along the line ahead of the saw cut for easier operation and longer blade life.

MAINTENANCE

Cleaning

⚠WARNING: Always wear eye protection while operating this power tool.

Periodically blow out all air passages with dry-compressed air. All plastic parts should be cleaned with a soft damp cloth. Never use solvents to clean plastic parts. They could possibly dissolve or otherwise damage the material.

If replacement of the power cord is necessary, the tool should be taken to a DeWALT factory service center, a DeWALT authorized service center or other qualified service personnel in order to avoid a safety hazard. To locate an authorized service center, please contact DeWALT Industrial Tool Co., 20 Fletcher Road, Mooroolbark, VIC 3138 Australia or call (AUS) 1800 654 155 or (NZ) 09 526 2556.

Lubrication

This tool has been lubricated with a sufficient amount of high-grade lubricant for the life of this unit under normal conditions. No further lubrication is necessary.

Brush Inspection

For your continued safety and electrical protection, brush inspection and replacement on this tool should only be performed by a DeWALT factory service center, a DeWALT authorized service center or other qualified service personnel. At approximately 100 hours of use, take or send your tool to your nearest authorized service center to be thoroughly cleaned and inspected. Have worn parts replaced and lubricated with fresh lubricant. Have new brushes installed and test the tool for performance.

Any loss of power before the above maintenance check may indicate the need for immediate servicing of the tool. DO NOT CONTINUE TO OPERATE THE TOOL UNDER THIS CONDITION. If proper operating voltage is present, return the tool for immediate service.

Repairs

To assure product SAFETY and RELIABILITY, repairs, maintenance and adjustment (including brush inspection and replacement) should be performed by certified service centers or other qualified service organizations, always using identical replacement parts.

ACCESSORIES

⚠WARNING: Always wear eye protection while operating this power tool.

⚠WARNING: The use of any other accessory not recommended for use with this tool could be hazardous.

Recommended accessories for use with your tool are available at extra cost from your local service center. If you need any assistance in locating any accessory, please contact DeWALT Industrial Tool Co., 20 Fletcher Road, Mooroolbark, VIC 3138 Australia or call (AUS) 1800 654 155 or (NZ) 09 526 2556.

Guarantee

Applicable to hand held Power Tools, Lasers and Nailers.

Three Year Limited Warranty

DeWALT will repair, without charge, any defects due to faulty materials or workmanship for three years from the date of purchase. Please return the complete unit, transportation prepaid, to any DeWALT Service Centre, or any authorised service station.

For warranty repair information, call (AUS) 1800 654 155 or (NZ) 09 526 2556.

This warranty does not apply to

- Accessories
- Damage caused where repairs have been made or attempted by others.
- Damage due to misuse, neglect, wear and tear, alteration or modification.

This warranty gives you specific legal rights and you may have other rights under the provisions of the Consumer Guarantee Act 1993 (New Zealand only), Trade Practices Act 1974 and State Legislation (Australia only).

In addition to the warranty, DeWALT tools are covered by our:

FREE ONE YEAR SERVICE CONTRACT

DeWALT will also maintain the tool for free at any time during the first year of purchase. This includes labour, parts and lubrication required to restore the product to sound mechanical and/or electrical condition. Normal wear parts are not covered in this service. Carbon brushes worn more than 50% will be replaced.

NOTE: Three Year Warranty is not applicable to items deemed as consumables. Radial arm saws are covered by a one (1) year warranty only. DeWALT Reserves the right to review its warranty policy prior to launch of any new business development products.

30 DAY NO SATISFACTION GUARANTEE

If you are dissatisfied with any DeWALT power tool, laser or nailer, for any reason, simply return it to the point of purchase with your sales receipt within 30 days for a replacement unit or a full refund.

FREE WARNING LABEL REPLACEMENT: If your warning labels become illegible or are missing, call (AUS) 1800 654 155 or (NZ) 09 526 2556 for a free replacement.

FIG. 1

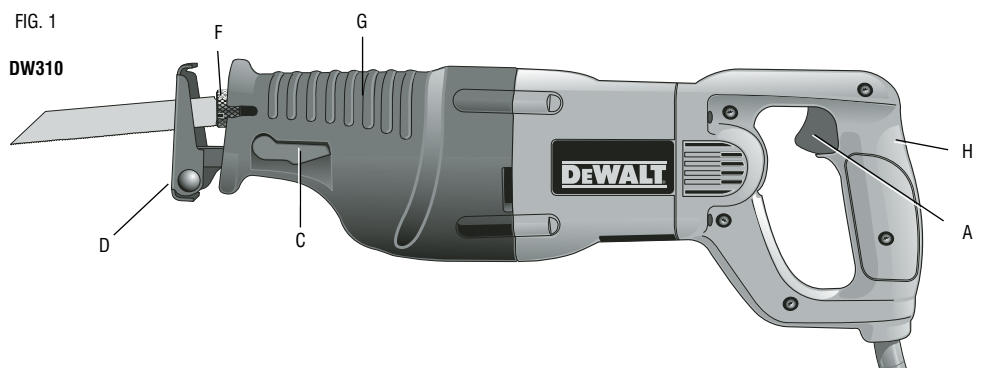

FIG. 2

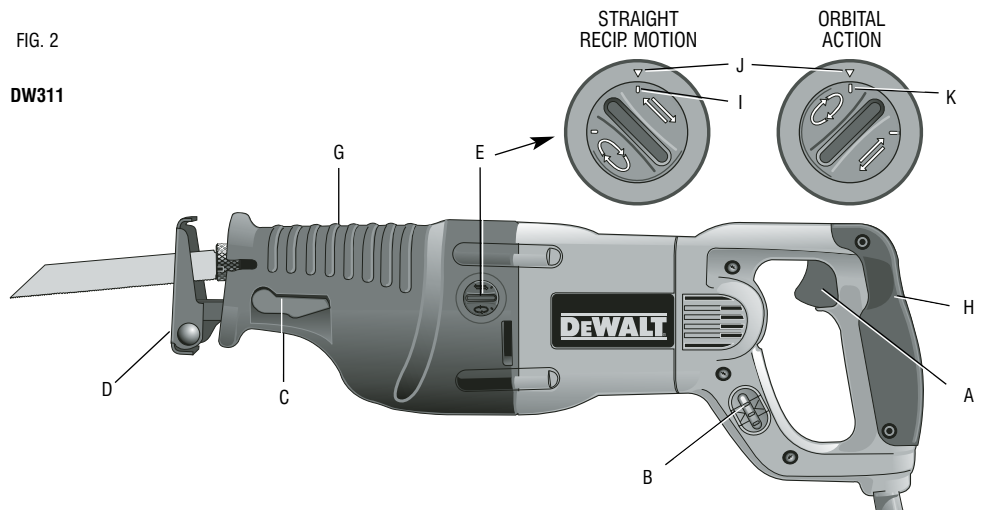

FIG. 3

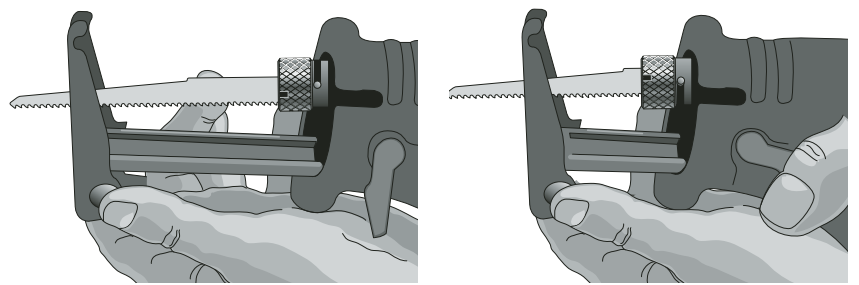

FIG. 4

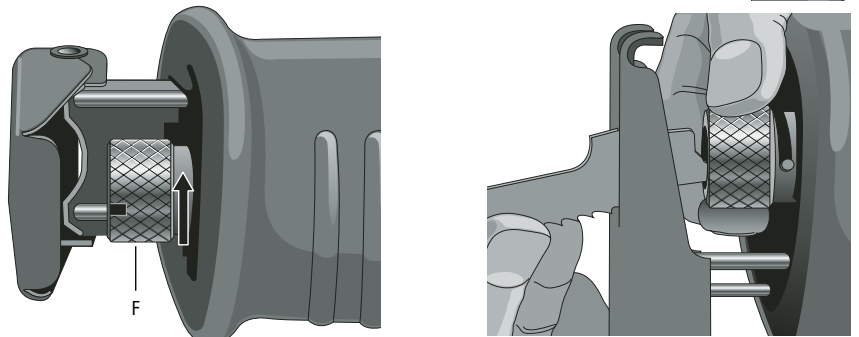

FIG. 5

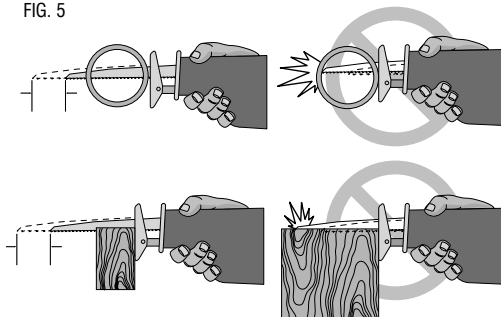

FIG. 6

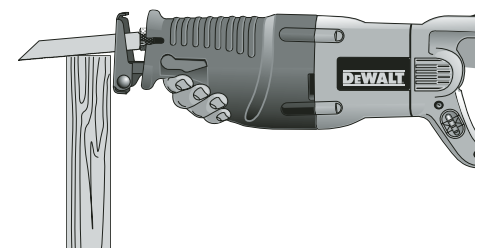

FIG. 7

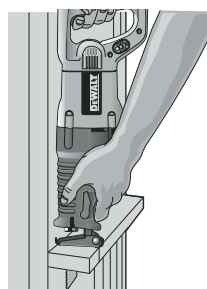

FIG. 8

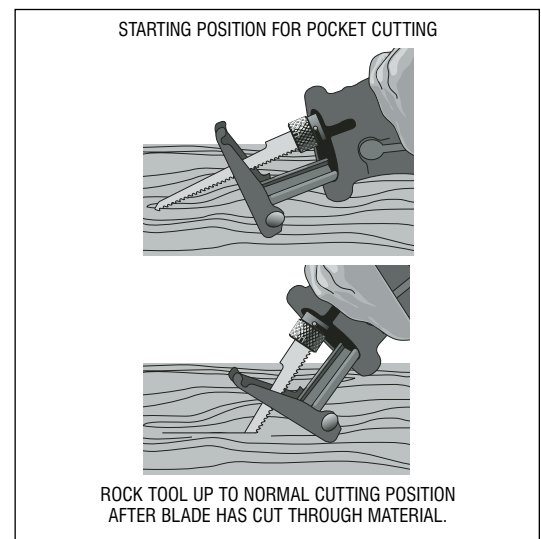
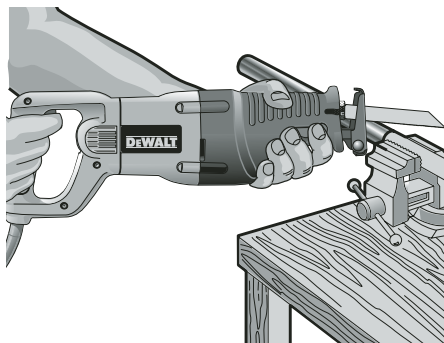

FIG. 9



FREE WARNING
REPLACEMENT LABEL

